

STRICTLY CONFIDENTIALFOR PHILIPS SERVICE
DEALERS ONLY

■

COPYRIGHT 1937

PHILIPS
SERVICE MANUALDE LUXE SUPERHETERODYNE
ALL-WAVE
MULTI-INDUCTANCE RECEIVERS.**Type 794A.**

TABLE MODEL

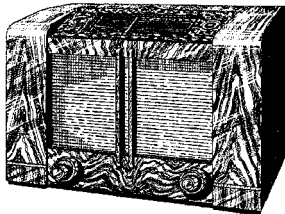
**GENERAL REMARKS.**

This receiver is designed for reception of the following ranges:—

16.5—51 metres (18.2—5.9 M.C. Short Wave).
198—585 metres (1,515—521 K.C. Medium Wave).
725—2,000 metres (414—150 K.C. Long Wave).

It is equipped with the following. Delayed automatic volume control; visual tuning indicator operating on the cathode ray principle; variable band-width control together with a variable tone filter. A special type of quality corrector circuit, connections for a gramophone pick-up, connections for an additional loudspeaker of high impedance, and a separate switch for switching off the incorporated loudspeaker is also fitted.

The receiver is also arranged for reception on mains aerial, which is controlled by a switch on the extreme left looking at the back.

A safety switch in the form of a plug, is fitted to the removable back which ensures that the receiver is entirely safe to handle when the back is removed. Looking at the front of the receiver, the large knob on the left-hand side of the cabinet is for adjusting the band-width over half its travel, while with the remaining half the tone filter is brought into use. The smaller knob on the left-hand side is the volume control. The large knob on the right-hand side of the cabinet controls the waveband and also the on/off switch. The smaller knob on the right-hand side is for tuning. The mechanical silent tuning is operated by pushing in the small knob on the left-hand side.

The tuning control has two adjustments. The main control operates as soon as the stop at the back of the unit engages against the main control and enables rough tuning to be obtained. Immediately the tuning control is moved from the stop, vernier tuning comes into operation until the stop engages against the opposite side.

The receiver is designed for a mains frequency of 50—100 cycles and mains voltages of 100 v., 125 v., 145 v., 200 v., 220 v. and 245 v. The voltage range can be seen through a small hole at the back indicating the voltage for which the receiver is set.

DESCRIPTION OF CIRCUITS.

The following particulars describe the circuits in the medium wave position. The aerial voltages which are received are coupled inductively (S7) and capacitively (C28) with S9. S9 forms together with C10, the trimmer C14, and the coupling condenser C30 the first tuned circuit of the capacitively coupled bandpass filter, while the second tuned circuit consists of S11, C11, C30, C15. The voltage across C11 is fed via R32 to the fourth grid of L1. R32 is fitted to prevent parasitic oscillation when the short wave range is in use.

The tuned circuit of the oscillator, consisting of S14, C12 in parallel with the padding condenser C17 and the series padding condensers C20 and C33, is connected to the first grid of L1 (FC4). The coil S16 is coupled to S14 and connected to the second grid of L1. The cathode, together with the first and second grids of L1, should be regarded as an oscillating

triode, operating at a frequency of 128 K.C. higher than the frequency to which the H.F. circuits are tuned. The difference in tuning between the H.F. circuits and the oscillator circuits is maintained reasonably constant with the aid of the padding condensers.

The ultimate difference in frequency between the two circuits is passed to the coil S20 which is tuned by the condenser C22.

The intermediate frequency voltage across S20 is induced into the coil S21 which, together with C23, is also tuned to 128 K.C. The two circuits form together an inductively coupled I.F. tuned filter, and the width of the band can be regulated by altering the distance between the two coils. This system forms the selectivity control which is operated by rotating the left-hand knob on the front of the cabinet.

The intermediate frequency voltages are coupled by the valve L2 (VP4B) and are passed via the tuned circuits S22, C24, S23 and C25 to the valve L3 (TDD4).

It will be observed that S23 and S24 are tapped and connected to the first diode of the double diode triode valve. This connection is made to produce a smaller damping effect. The voltages across S24 are rectified and consequently a D.C. with a super imposed L.F. A.C. is set up. This current flows through the circuit via the first anode, cathode, R14, R15 and S24.

The low frequency A.C. component voltage is also passed through R15, which is the volume control, and also to the grid of L3 via the condenser C37 and the resistance R16. The low frequency voltages are again passed to the anode of the triode section of L3 and amplified by a resistance capacity coupling circuit before being connected to the control grid of L4.

The condenser C41 is for tone compensation and suppresses very high frequencies. The function of R28 and R26 is to act as grid stoppers. R20, C42 and R22 form the continuously variable tone filter. C39 is a filter condenser for the I.F. frequency. R18 is the anode coupling resistance for L3, C40 is the coupling condenser between L3 and L4 and R19 the grid coupling resistance for L4. The second diode anode of L3 is, owing to the voltage difference across R6, R7 and R8, negative relative to the cathode, so that no current will pass above a predetermined value, and consequently the automatic volume regulation is retarded.

The I.F. voltage will reach the second diode anode via C36. When a strong signal is received a current will flow in the circuit, second diode, cathode, R6, R7, R8 and R13, therefore the voltage at the second anode becomes more negative. This voltage is fed as an extra negative grid voltage to the fourth grid of L1 via R12, R10, S11 and therefore regulates the voltage to the grid of this circuit.

The voltage on the control grid of L2 is also controlled by the extra negative voltage which is developed across the resistance R15. The latter voltage is fed via R24 and S21 to the control grid of L2 and decoupled by the condenser C43.

The circuit of L8 (TV4 tuning indicator) consists of a normal triode section and also a target electrode which exhibits fluorescence under electronic bombardment.

The larger anode is the plate of the triode section and connected to a high voltage through R36. This anode has four other plates attached which are disposed in the form of a cross around the cathode and is fitted between the latter and the fluorescent plate. When the four plates have a lower voltage than that on the plate represented obliquely they exercise a screening effect on the electrons attracted to the latter plate.

When the receiver is being tuned into a station the grid becomes more negative. Therefore the plate current and also the voltage drop across R36 decreases.

The anode, together with the four plates, will then rise to a higher potential with the result that the screening action will diminish and consequently illuminate the cross over a wider area.

The TV4 should be operated so that full illumination is obtained when the receiver is tuned to a station.

The special quality corrector circuit consists of the resistance R6 and choke coil S25, both of which are switched in series with the resistance R21 and coil S29. This circuit is in parallel with the secondary winding of the loudspeaker transformer S27.

Further points to be mentioned are C46 and C47 which are designed to suppress frequencies which are higher by twice the I.F. frequency than the frequency to which the H.F. circuit is tuned.

S6 and C13 are tuned to the I.F. frequency (128 K.C.) and consequently by-passes signals of this frequency to earth, in order to avoid interference with the I.F. filters of the receiver.

The various negative grid bias voltages to the valves are obtained by the cathode resistance method. The condensers are connected in parallel for decoupling H.F. or L.F. By connecting the aerial circuit with C26 by means of the Mains \bar{A} switch, the receiver is connected to the mains aerial.

L5 is a full-wave rectifier, while C1, S5 and C2 form the smoothing filter. When the long wave band is in use the following coils, condensers and resistances are included in the circuit.

Aerial Circuit.—S7 and S8.

H.F. Circuit.—C28, S9, S10, C10, C14, C29, C30, S11, S12, C11 and C15.

Oscillator.—Grid circuit: S14, S15, C12, C17, C18, C19, C32, C20 and C33.

Anode circuit: S16, S17.

When the receiver is adjusted for short wave reception the following component parts are switched in.

Grid Circuit of L1, S13, C11 and C31.

Oscillator.—Grid circuit: S19, C12, C16, C34 and R11.

Anode circuit: S18.

When the receiver is in use with a gramophone pick-up the aerial connection is open circuited. The grid circuit of L1 is short circuited and the voltage for the anode of the oscillator is open circuited. The negative grid voltage is increased by removing the short circuit on R31. R27 is then in parallel with R6. At the same time R16 is short circuited so that the voltage across R15 is considerably amplified for gramophone reproduction.

The two switches which are marked A and B on the diagram are controlled by the switch which is marked at the back "full bass and reduced bass." They are shown in the diagram in the position of "reduced bass."

TRIMMING THE RECEIVER.

A receiver is equipped with trimming condensers for the purpose of balancing out any possible differences that may exist in the capacity of the tuning circuits. If this is not done, the full amplification and selectivity would not be obtained owing to the tuning circuits not being "in step."

The I.F. circuits are always trimmed first because the I.F. amplification is made use of for further balancing operations in the receiver.

When the I.F. filter circuits are trimmed the bandwidth regulation must be adjusted to its maximum position.

When the primary winding of an I.F. transformer is being trimmed the secondary must be damped by a resistance, and again when the secondary is trimmed the primary must be damped.

This method is adopted because in very tightly coupled circuits two peaks will occur at resonance, therefore it would not be possible to trim the circuits satisfactorily. When a damping resistance is introduced one peak only is obtained.

In cases where the connecting points are difficult to reach the damping resistance can be fitted at the top of the circuit, namely either to the plate or grid side of the circuit and chassis.

A condenser of $0.1 \mu\text{F}$ must then be switched in series with the resistance so as to obviate the short circuiting of D.C. voltages. The condenser should be connected to the chassis and the resistance in the circuit.

The method of applying a signal to the control grid is shown via a condenser of $3,200 \mu\text{F}$ at Fig. 1.

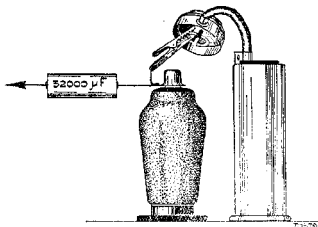

Fig. 1

The volume control should be adjusted to maximum, but should the signal become too strong, the attenuator of the local service oscillator should be adjusted to a suitable level.

In connection with the trimming of the H.F. and oscillator circuits, the following details should be noted. The oscillator circuit is tuned to a frequency of 128 K.C. higher than the frequency to which the H.F. circuits are tuned in the case of the M.W. and L.W.

It is essential that the condenser is, to begin with, in a predetermined fixed position, namely 15° from the minimum. It can be adjusted by the aid of the template, Fig. 2.

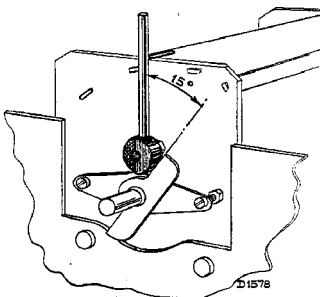

Fig. 2

When the variable condenser is adjusted the trimming can be carried out with the trimmers of the H.F. circuits and the parallel trimming condenser of the oscillator circuit. When trimming the H.F. and oscillator circuits, the band width regulator should be adjusted to the narrow band width position in order to obtain a maximum reading as sharply outlined as possible, i.e., without a double peak.

The circuits in the upper part of the frequency range are now satisfactorily adjusted, but they must also be readjusted for the lower part of the frequency range; although it is possible to obtain a maximum output of the variable condenser it does not necessarily imply that the H.F. circuit is exactly tuned to the whole of the frequency band or that the oscillator circuit is exactly tuned to 128 K.C. higher than the H.F. circuits. It is, therefore, necessary to recheck the H.F. circuits. Finally the series padding condenser is adjusted for maximum output. The exact tuning of the H.F. circuits is carried out with an auxiliary receiver or by an aperiodic amplifier (GM.2404). This adjustment is carried out as follows:—A signal is applied to the aerial socket of the receiver via an artificial aerial. A resistance of 2,000 ohms is connected across the primary of the first I.F. transformer and the plate of L1 is connected, via a condenser of $25 \mu\text{F}$, to the aerial socket of the auxiliary receiver or amplifier. The output indicator is connected to the auxiliary apparatus and this is tuned to the required signal. The circuits to be trimmed are adjusted to maximum output so that the H.F. circuits are exactly adjusted to the imposed frequency.

The auxiliary apparatus and the damping resistance are then removed and the output indicator is connected to the receiver to be trimmed. The circuit, together with the series padding condenser, is then adjusted to its maximum output. As the variation of the value of the series padding condenser slightly affects the upper section of the frequency range it is important that the trimming process should be repeated in order to avoid errors.

When the short wave band is being trimmed, every care must be taken so that the oscillator circuit of this wave band is adjusted to a frequency of

128 K.C. lower than the frequency to which the H.F. circuits are to be adjusted. That is to say, if two maximum positions are found with the oscillator trimmer the position showing the largest capacity of the trimmer (turning to the right) is the correct one.

The trimming of the receiver can be done without removing the chassis from the cabinet ; only the bottom plate need be removed.

Before the trimmers are adjusted it is desirable to make the wax slightly soft with a soldering iron. When adjusting C16 use should be made of a screwdriver with as small a metallic section as possible (for instance Code No. 09.991.501).



Fig. 3

The larger type of trimmer can be more easily adjusted with the screwdriver, Code No. 09.991.050.

It is important that the adjusting of the trimming condensers should be carried out with care as otherwise the connecting wires which are soldered to the top of the adjusting screw will work loose.

In all cases it is essential that the receiver is trimmed with the valve FC4 which is supplied with the receiver. If this valve is changed at any time during the operation it will be necessary to retrim the oscillator circuits.

As the rectifier 1821 has a low impedance, it is desirable to use a type 1823 when repairing or trimming.

THE FOLLOWING INSTRUMENTS AND TOOLS WILL BE REQUIRED FOR TRIMMING.

1. A service oscillator similar to Philips Type GM.2880. All-mains Oscillator. Fig. 4.

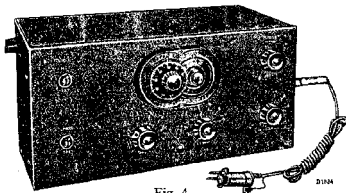

Fig. 4

2. An output indicator similar to that which is fitted to the Universal Measuring Testboard, or the special Adaption Box GM.2295, which can be placed between the receiver to be trimmed and a moving coil instrument.
3. A 15° template (Code No. 09.991.470). Fig. 2.
4. An auxiliary receiver or aperiodic amplifier (GM.2404).
5. Insulated trimming screwdrivers (Code No. 09.991.510 and 09.991.450).
6. Type 1823 rectifier.

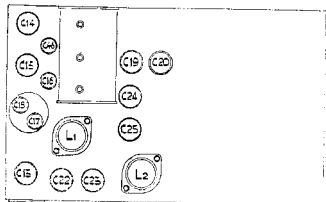

Fig. 5

TRIMMING THE I.F. AND OSCILLATOR CIRCUITS.

1. Set the band width control to maximum. Adjust the receiver to long wave range and set variable condenser to 800 metres.
2. Apply a modulated signal of 128 K.C. to the control grid of L1. (Fig. 6).
3. Fit a resistance of 25,000 ohms (Fig. 6) across C24, trim C25 (Fig. 5) to maximum output. After trimming remove the resistance.
4. Fit a resistance of 10,000 ohms across C23 and 0.1 μ F condenser in series between control grid of L2 and chassis ; trim C22. After trimming remove the resistance and condenser.
5. Fit a resistance of 25,000 ohms across C25 ; trim C24. After trimming remove the resistance.
6. Fit a 10,000 ohm resistance across C22 and a 0.1 μ F condenser in series ; trim C23. After trimming remove the resistance and condenser.

Note.—During the I.F. trimming the cabinet can be laid on one of its sides. When trimming the H.F. sections the cabinet should stand vertically.

TRIMMING THE H.F. AND OSCILLATOR CIRCUITS.

1. Set the band width control to minimum.
2. Fit a 15° template, Fig. 2.
3. Turn C13 almost to its maximum position.

Medium Wave Range.

1. Place the condenser against the 15° template. Fit the output indicator and switch the receiver to the medium wave range.
2. Apply a modulated signal at 1442 K.C. (208 metres) via the standard artificial aerial to the aerial socket. Trim C17, C14 and C15. These condensers are the oscillator and band pass filter condensers respectively.
3. Adjust the service oscillator to 550 K.C. (545 metres) increase the signal until it is very strong.
4. Connect the auxiliary receiver or amplifier, namely, with test pin Code No. 09.991.620, for instance, through the hole M in the chassis, Fig. 6.

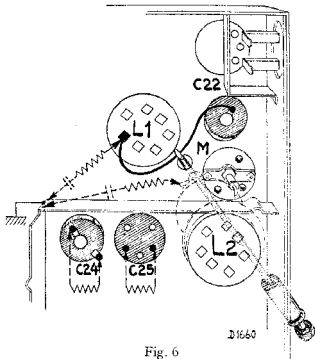

Fig. 6

Damp C22 (first I.F. condenser) with a 2,000 ohm resistance in series with an 0.1 μ F condenser and tune the H.F. section to be trimmed.

5. Remove the auxiliary apparatus and the resistance of 2,000 ohms across the condenser C22, and trim the padding condenser C20.
6. Repeat Nos. 2—5 for satisfactory results.

Note.—When trimming as shown at 2, oscillation may occur. Further trimming should be effected until the correct position be obtained.

Long Wave Range.

1. Apply a modulated signal of 395 K.C. (760 metres) via a standard artificial aerial to the aerial socket and tune the receiver.
2. Turn the condenser to the 15° figure and trim C18.
3. Adjust the service oscillator to the 160 K.C. (1,875 meters) with a strong signal. Connect the auxiliary receiver and tune.
4. Remove the auxiliary apparatus and the 2,000 ohms across C22. Trim C19 for maximum output.
5. Repeat the operation from 1 to 4.

Short Wave Range.

1. Apply a modulated signal of 17 M.C. (17.6 metres) to the aerial socket via a short wave artificial aerial. Switch the receiver to short wave.
2. Place the condenser to 15° template, trim C16 (the signal for the short wave should be that which takes the greatest trimmer capacity).

I.F. Aerial Filter.

Place a strong modulated signal of 128 K.C. to the aerial socket. Switch the receiver to the long wave range. Place the variable condenser to the maximum position, namely 2,000 metres, and trim C13 to the minimum output.

Image Frequency Filter.

1. Place a modulated signal of 744 K.C. (403 metres) to the aerial socket. Tune the receiver.
2. Place a strong modulated signal of 1,000 K.C. (300 metres) to the aerial socket. Trim C46 for minimum output.

Adjusting the Tuning Scale.

When carrying out repairs where the scale must be re-adjusted, it will be necessary to re-secure the moulded scaleholder on to the drive after removing the chassis from the cabinet.

The new adjustment of the indicating needle should be carried out with a wavelength of 208 metres, as this is the most suitable part of the scale to obtain the greatest accuracy.

The following is the method:—

Apply a signal of 1,442 K.C. (208 metres), tune in the receiver and set pointer to 208 metres. Apply a signal of 857 K.C. (370 metres) and check to make sure that it is correctly in position.

Finally apply a signal of 550.4 K.C. (545 metres) and tune again. If the calibration is inaccurate it will be necessary to displace the drum disc as shown in the table below by means of the screw on the left-hand side of the drum drive bracket.

351 metres.	545 metres.	208 metres.
Good	Too high	↑
Good	Too low	↓
Too high	Too high	←
Too high	Good	↓
Too high	Too low	↓
Too low	Too high	↑
Too low	Good	↑
Too low	Too low	→

Each time the bracket is shifted it will be necessary to re-tune again to 208 metres and correct the indicator.

HOW TO TRACE FAULTS.

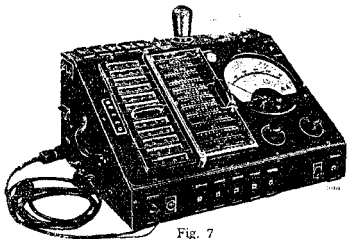

Fig. 7

GENERAL REMARKS.

Fault finding will be considerably facilitated by the use of efficient testing apparatus. Attention is drawn to Philips Universal Measuring Testboard shown at Fig. 7, which enables both A.C. and D.C. voltages and currents, capacities and resistances to be measured over a large number of ranges. Particulars and prices of the testboard and service oscillator, Fig. 4, can be obtained from the Service Dept., Mitcham Junction, Surrey.

Attention is drawn to the "point to point" system of measurement; the various test values are shown on page 9.

In general it may be said that the majority of faults are due to short circuits in the wiring or to open or short circuits in one of the component parts. These are indicated as R— or C— shorted or open circuited.

The method of test to be followed is shown below:—

- I. Place a set of known satisfactory valves in the receiver, and, if necessary, try another loud-speaker.
- II. Test if gramophone reproduction is possible from gramophone pick-up sockets.
- III. Check the voltage across C2 by measuring between the loudspeaker transformer primary and chassis. If this value is abnormal, then any of the following defects may have occurred.
 1. A fault in the mains switch or in the voltage adjusting disc. (Measure the primary voltage to the mains transformer.)
 2. A defect in the mains transformer. (Measure the secondary voltage.)
 3. A defect in L5.
 4. C1, C2, C5, C6 short circuited.
 5. S5 open circuited.
 6. Open circuit or short circuit in the heater voltage supply.
 7. A defect in one of the I.F. transformers.
 8. A short circuit between the primary and secondary windings of the loudspeaker output transformer.
 9. A faulty contact in one of the valve holders.

IV. Voltage across C2 normal but no gramophone reproduction.

A. L4 has abnormal current and voltages.

1. No anode current; S26, R9 open circuited.
2. Anode current too high; C4, C40 short circuited.
3. R20, R28, R26 open circuited.

B. L3 has abnormal current and voltages.

1. No anode current; R3, R18, R6, R7, R8 open circuited, C7, C39 short circuited.
2. Anode current too high; C3 short circuited.
3. R17 open circuited.

C. L3 and L4 have normal current and voltages but no radio or gramophone reproduction.

1. Short circuit in one of the screened connections; for instance the control grid of L3.
2. Short circuit in the loudspeaker transformer.
3. C40, R15, C37, R16 open circuited.

V. Gramophone but no radio reception.

A. L2 has abnormal current and voltages.

1. No anode current; S22, R5, R38 open circuited.
2. Anode current too high; C9 short circuited.
3. R1, R24, R25, S21 open circuited.

B. L1 has abnormal current and voltages.

1. No anode current; S20, R4 open circuited.
2. Anode current too high; C8 short circuited.
3. Anode current low; R1 open circuited. R31 not being short circuited by switch. Switch No. 1 bad contact.
4. R11, R32, S16, S17, S18 open circuited.

C. L1 and L2 has normal current and voltages, but no wireless reception.

1. No reproduction of a modulated I.F. signal of 282 K.C. when it is connected to the control grid of L2; grid cap not connected. S22, S23, S24, C24, C25, C38 short circuited. R14 open circuited.
2. No reproduction of modulated I.F. signal of 128 K.C. transmitted through control grid of L1; grid cap not connected but connected to the control grid of L2. S20, S21, C22, C23 short circuited.
3. No reproduction of a modulated H.F. signal to the fourth grid of L1, although reproduction of I.F. signal transmitted to the same part of the circuit. One of the coils or condensers in the oscillator section of L1 is either open or short circuited, C12, C18, C33, R11, etc.

4. No reception of a modulated H.F. signal connected to the aerial socket, although reception is obtained at the fourth grid of L1 (grid cap not connected). Open circuit in one of the coils or condensers in the aerial circuit or fourth grid circuit of L1, for instance C10, C11, C29, C30, C7, C8, C9, C10, S11, S12. S6 short circuited, weak on long wave range.

VI. Wireless reception and gramophone, but quality not satisfactory.

A. Automatic volume control not functioning.

1. R13, R12, R10, C36 open circuited.
2. C29, C30, C35, C43 short circuited.

B. Receiver oscillates.

One of the decoupling condensers is open circuited or the screening of the wiring is open circuited, for instance C8, C9, C5, C7, C44.

C. Receiver hums.

C1, C2 open circuited, S5 short circuited.

D. Cabinet resonances.

The normal cause of this is due to some loosely fitting part, such as grid caps, loose washers, strips or screws. When the vibrating parts have been detected a slight adjustment will generally cause the vibration to disappear.

E. T.V.4 not operating.

1. R34, R35, R36 open circuited.
2. C27 short circuited.

F 1

FAULT FINDING BY THE "POINT TO POINT" METHOD.

By making use of the "point to point" system in conjunction with the Universal Testboard it is possible to locate a fault in a receiver rapidly and systematically. A further advantage is that the chassis need not be removed from the cabinet.

- I. The receiver is connected up to the rated voltage and tested with its own valves on an outside aerial or service oscillator.
- II. Should the receiver not function the valves should be replaced by another set of valves from a satisfactory instrument, and possibly another loudspeaker fitted. In this way a defect in one of the valves or loudspeaker can be eliminated.
- III. A gramophone pick-up is connected to the receiver. If the reproduction is satisfactory the fault will be located in the H.F. or I.F. section by testing from the detector back to the aerial socket.

A low frequency signal should be transmitted via a condenser of 0.1 μ F to the control grids of each valve in succession.

- IV. If the gramophone reproduction cannot be obtained or if the measurements of the H.F. circuits give no result, the following method should be adopted.

1. All valves are removed from the receiver and a dummy valve base is inserted into the valve holder of the rectifying valve. The plate and the heater contacts are connected together. The receiver should not be connected to the mains.
2. The Universal Measuring Testboard (Type 4256) should then be adjusted for resistance measuring (Position 12). The positive pin of the flexible test lead should be long enough so that it can readily reach various contacts of the valve holders, etc., while the other test flex is plugged into the earth socket of the receiver.
3. The various resistances between the points and chassis indicated in the accompanying table, are measured by touching each contact with the positive pin. The reading obtained should then be compared with the value shown on the table.

G. or U. indicates that measurements should be taken between the gramophone pick-up sockets and earth. 21/22 indicates that a

measurement should be taken between the points 21/22. S.M.L. or G. indicates that the switch is placed to short, medium, long or gram.

It is possible for discrepancies of 10% to occur without the component part being necessarily defective.

4. When the resistances have been measured the testboard should be adjusted for capacity measurement.
5. When a test is carried out on the rectifying valve holder the short circuited base should be temporarily removed. By this means all the circuits can be measured and by comparison with the diagram the defective component part can be readily identified.

The contacts on the valve holders are systematically numbered in the following way. The first number indicates the valve holder and the second number indicates:—

- 1 & 2 = heaters.
- 3 = control grid.
- 4 = metallising contact.
- 5 = cathode.
- 6 = extra grid.
- 7 = a screening grid.
- 8 = anode.
- 9 = an extra grid (for instance when employed in the octode).

From the table of measurements it will be clearly seen that the numbers are grouped according to the value of the resistance or capacities, so that all grid circuits (13, 23, 33, etc.) are measured in Position 9.

On the other hand, all heater contacts and cathode connections have a very low resistance. In some measurements it may be necessary to adjust the wavelength switch. When this is necessary it is indicated in the table as:—

4X	4X
---	---
Aerial	13

When measurements are made on electrolytic condensers (resistance measurement) a deflection will swing back until the leak current is reduced. It is possible that the values then are too high owing to the condenser being defective. It is also possible for a high reading to occur if the instrument has not been in operation for some time. It is therefore necessary to exercise a certain amount of caution when testing electrolytic condensers.

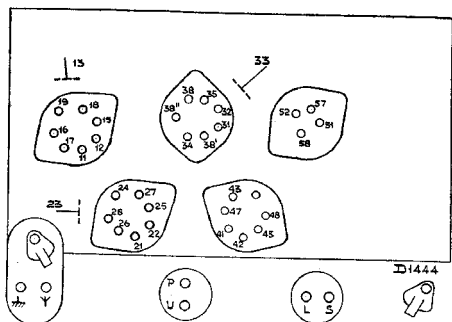

RESISTANCES.

12	4X				11	21	31	41	24										
	Aerial				12	22	32	42	34	P									
	S	M	L	G															
	500	375	465	500	5	5	5	5	5	5									
11	4X				4X				18	25	26	28	45	47	48	57		L	S
	15				13											58			
	S	M	L	G	S	M	L	G											
	290	290	290	470	110	500	500	110	375	435	435	460	230	360	405	220	350	410	
10	16	17	19	27	35	52	19 on												
	145	185	280	485	475	51	Gram												
							O												
9	23	38	38'	38"	43	U on		33											
	80	365	225	210	150	Gram		100											

CAPACITIES.

12	4X				33	38	38'	43											
	13																		
	S	M	L	G															
	500	400	365	500	45	345	180	235											
11	17	23	27																
	285	290	350																
10	48																		
	280																		
9	35	45	52																
	470	460	475																

G 1

REMOVING AND CHANGING OF PARTS.

Repairing and trimming will be greatly facilitated by the use of the Universal Chassis Holder (see Fig. 8).

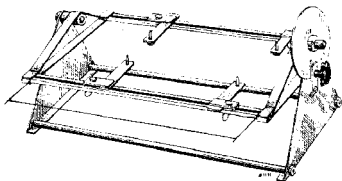

Fig. 8

The chassis is secured to the holder by four screws, and it can then be rotated about its longitudinal axis and can also be secured in any predetermined position with the aid of the brake-disc at the side of the chassis holder. It can be adapted for chassis of varying dimensions. Special attention is drawn to the following points:—

1. Do not make any alteration in the wiring or screening plates.
2. Make sure that all the wires are kept clear of each other, not less than $\frac{1}{8}$ in.
3. Replace all spring washers, insulated material, etc., in their original places. If necessary rivets may be replaced by screws and nuts.
4. All moving parts unless otherwise stated may be greased with a little pure vaseline.
5. If necessary give the contacts a slight mechanical tension.
6. All soldering should be done as quickly as possible in order not to heat various parts.
7. All soldered joints to the leads of compound treated condensers should be soldered $\frac{1}{8}$ in. from the compound in order to avoid overheating. Further, these condensers should be suspended clear of other wiring.
8. It is necessary to make quite sure that the resistances do not make contact with other parts which are in close proximity in order to avoid undue effects which may develop by the heat emanating from the resistances. When the cabinet is placed bottom upwards (on a piece of felt or similar material) it is possible to reach the majority of components inside the chassis by removing the fibre sub-bottom plate. Practically all electrical faults and many mechanical ones can be remedied without taking the chassis from the cabinet. The chassis must never be lifted by the coils.

REMOVING THE CHASSIS FROM THE CABINET.

This should be carried out in the following manner:—

1. Remove the chassis screws on the underside of the cabinet.
 2. Unsolder the connections on the terminal strip of the loudspeaker and output transformer, and also the connection to the bottom screening. Mark them for identification.
 3. Unscrew the cable which is attached to the indicating pointer with screw A, Fig. 16.
 4. Release screw B almost complete with the aid of a screwdriver (Code No. 09.991.770). Loosen the screw cap C and release the end of the cable.
 5. Release screws D. Release the bowden wire from the fixing eyelet of the loudspeaker if fitted. The scale drive can now be removed (see Fig. 16, page 18).
- Withdraw chassis from cabinet.

ELECTROLYTIC CONDENSERS.



Fig. 9

When removing an electrolytic condenser, a spanner should be used (Code No. 09.991.540), see Fig. 9.

SECURING THE COILS AND TRIMMERS.

The coils are secured to the chassis by means of small flanges which form a part of the chassis. When the connections to the coil have been unsoldered the coil should be carefully removed from the chassis and a new coil fitted with the aid of a special tool. Should, however, it be found that the flanges have broken off the coil can be securely fixed with the aid of a clamping plate. This special type of clamp may be obtained from the Service Department. The clamping plate is fitted into the opening on the chassis so that the coil box is firmly fitted.

DRIVING MECHANISM.

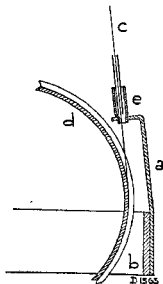

Fig. 10

The small brackets (a) which are riveted to the large brackets (b) and into which the push cable (c) is fitted, must be positioned in such a manner relatively to the drum (d) (see Fig. 11) so that the centre line of the aperture of the part (e) is at a tangent to the bottom of the groove in the drum.

Furthermore the opening of the part (e) must lie exactly opposite the deepest part of the drum, otherwise the driving cable will tend to run against one of the side edges of the drum and slip off.

The small part (e) must be soldered to the bracket (a) and care must be taken that these parts have no sharp edges, and also that solder does not run in to them.

The driving cord can be supplied in suitable lengths, and should, prior to being used, be stretched for approximately one minute with a tension of approximately four pounds.

It is essential that the driving cord is secured in the teeth of the lever situated close to the pivot point. The length of the cord must in every case be such that the tension spring is completely closed. If the cord is found to be too long it may be shortened by tying a knot.

BOWDEN WIRES.

These wires can be supplied per metre. The inner wire will be found to be of two types. The thick type A is used for driving the variable selectivity coil, while the thin type is employed to drive the indicator pointer.

It is pointed out that a very slight kink in the bowden wire may cause rough running together with backlash, so it is important that care should be taken when adjusting this part of the receiver.

The bowden wire may easily be cut with pliers, but it is necessary to smooth down the ends with a file. Care should be taken so that no projections are left on the outside, otherwise difficulty will be experienced in obtaining a good fit.

The ends of the inner wire should always be soldered with acid-free flux so as to avoid any slackening.

WAVELENGTH SCALE POINTER.

When readjusting this part of the receiver care should be taken to make quite sure that the condenser reaches its maximum position before the indicator pointer. If this is not done there is a possibility of the inner wire becoming too slack and running off the drum.

VARIABLE CONDENSER VERNIER ADJUSTMENT.

Slipping may occur if the fibre bands become too smooth or if the resilient strips do not press hard enough. This may be remedied by turning the fibre band round, or in the second case, by carefully placing a slight set to the resilient strips.

WAVELENGTH SWITCH.

The wavelength switch consists of one or more units; a stop plate to determine the number of positions, spindles, springs.

One unit (Fig. 11) consists of a stationary ring called the stator, a rotor, contact springs (b) which are secured to the stator with small staples (c); one or more springs (d) which maintains the rotor in alignment with the stator and also various types of contact members and connections (a).

The stator is provided with 24 apertures distributed over a circle. On one side of the stator 12 contact springs may be fastened; one aperture is always kept open between the springs to allow of securing the contact springs on the other side so that a total of 12 contact springs may be secured on either side of the stator.

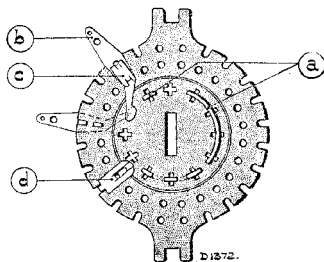

Fig. 11

EXPLANATORY NOTES OF THEORETICAL DIAGRAM.

In order to facilitate the reading of the diagram in connection with the wavelength switch, a brief explanation may be added.

The contact springs on the side of the stator that are fitted towards the stop plate are indicated as small circles in the outermost circle. When a contact spring is not fitted a dot is shown. Therefore a total of 12 circles can be shown in the outermost circle. In the innermost circle there are also 12 circles which indicate the contact springs on the opposite side of the stator.

Connections on the side of the rotor which turns towards the stop plate are shown as full lines in close proximity to the outermost circle. Those on the other side of the rotor are shown as a dotted line close to the innermost circle, while contact pieces are indicated as short lines between the inner and outer circles.

The rotor contacts cover one or more apertures and form, on one side, a section of a circle.

The contacts are provided with small lips which penetrate into the aperture of the rotor and by means of which the contacts are secured. The lip on the opposite side is used for contact purposes.

It is essential, therefore, that the lip should be compressed so as to be perfectly flat.

DESCRIPTION OF CONNECTING PIECES IN THE LIST OF SPARE PARTS.

The connections (Fig. 12) can be made up into various types, and a special method has been adopted so as to indicate quite clearly what type of connection is intended.

The first number specifies the number of apertures that are covered, while the other numbers indicate into which aperture the lip penetrates, from left to right.

For example, 4.1.4. denotes that four apertures are covered, and that, starting from left, the apertures 1 and 4 are made use of for securing purposes and also contact purposes on the other side.

Further, 5.2.3.5 denotes that five apertures are covered, and that the apertures 2,3,5 are used for securing and also contacts on the other side.

In the list of component parts these connections are specified in this manner, and therefore it enables the indication of the part and its code number to be determined very easily.

The contact springs of the rotor are supplied separately, and therefore it will be necessary for these to be secured by the service man. Special pliers can be supplied from the Service Department.

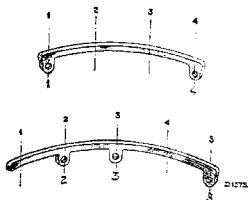

Fig. 12

LOUDSPEAKER. TYPE 9603.

It is important that care is taken when repairs are being carried out to make sure that the bench is free from dust, and that satisfactory tools are available. In no case should the front and back plates be removed, otherwise the magnetism will be affected. The protecting cover should be fitted immediately after the repair has been made in order to avoid dust entering the air gap.

In centring the cone four small distance pieces (Code No. 09.990.840) are required. These are placed into the air gap. When it is necessary to renew the

cone carried, or the pole piece requires adjusting, it will be necessary to use an air gap gauge shown at Fig. 13. Code No. 09.991.530.



Fig. 13

Before deciding that the loudspeaker requires repairing, it is desirable to test the receiver with another loudspeaker and, if necessary, with another transformer, in order to make quite sure that the fault is not in the receiver itself.

In cases of rattling or resonance it should be ascertained that this is not being caused by loose parts in the cabinet or by loose connections to the cone. Attention should also be paid to the possibility of dirt entering the air gap or the speech coil having become deformed.

After repair and recentring the cone can be carefully moved up and down to ensure that it is truly centred, Fig. 14.



Fig. 14

LIST OF COMPONENTS AND TOOLS.

When ordering spare parts or tools it is always necessary to specify :—

1. Code number.
2. Type number and serial number of the receiver.
3. Description of spare part, etc.

Fig.	Item.	Description.	Code No.
17	1	Cabinet	28.243.830
		Metallised paper	28.366.680
		Speaker silk	06.600.730
17	5	Escutcheon (colour 005)	23.690.134
		Lower section, rising scale (colour 005)	23.690.121
		Locking ring for rising scale	28.450.910
		Trade mark disc	28.936.331
		Station dial	28.705.170
17	2	Glass plate	28.339.060
		Window	28.702.840
17	3	Pointer	28.896.201
		Type plate	28.704.062
17	7	Small knob (colour 005)	23.610.250
17	6	Large knob (colour 005)	23.610.261
16	11	Back plate	28.400.220
16	9	Flatspring for backplate fixing (top)	28.750.040
16	10	Flatspring for backplate fixing	25.673.860
16	12	Cap for tapping switch	28.855.291
		Plate with pins	28.871.702
16	13	Safety contact (colour 111)	25.742.000
16	34	Speaker switch	08.529.340
16	35	Knob for speech/music switch	23.950.921
		Spindle for speech/music switch	28.616.652
		Speech/music switch and mains/aerial switch	08.524.690
		Bottom bush	28.890.300
16	14	Plug-pin plate	28.870.750
16	16	Plug socket plate	28.888.361
		Plug socket plate with switch	28.871.820
16	19	Knob for mains/aerial switch	23.610.231
16	17	Valve (grid) cap	28.855.310
16	21	Inner control cable A	33.635.590
		Inner control cable B	33.006.070
16	22	Outer control cable	33.635.050
16	23	Nipple	28.927.383
16	20	Eyelet	08.550.260
		Driving cord	06.606.290
		Cord clip	28.078.611
		Lever	28.914.333
		Spring for Bowden cable tensioning	28.750.462
		Spring for driving cord	28.730.600
18	28	Vernier unit	28.882.080
		Spring for vernier unit	28.751.810
		Locking ring for tuning spindle	07.891.011
18	26	Mains switch	08.529.570
18	31	Valveholder 7-pin	28.225.420
18	32	Valveholder 5-pin	28.225.900
		Valveholder for T.V.4 tuning indicator	25.161.921
18	33	Nut for electrolytic condenser	07.093.020
18	30	Rotor	28.477.210
18	29	Stator	28.934.580
		Rotor contact 1.1	28.904.161
		Rotor contact 2.1	28.904.260
		Rotor contact 2.2	28.904.390
		Rotor contact 3.2	28.904.211
		Rotor contact 4.1.4	28.904.182

LIST OF SPARE PARTS, TOOLS, GAUGES, TEST GEAR, ETC.—continued.

Fig.	Item.	Description.	Code No.
		Rotor contact 4.2.4	28.904.290
		Stator contact	28.750.970
		Clip for stator contact	28.077.391
		Guide bracket	28.077.380
		Spring for W/L switch	28.751.890
		Ball for W/L switch	89.205.040
		Clip for coil and trimmer fixing	28.080.870
18	24	Clamp for loudspeaker fixing	25.012.210
		Spindle for volume control	28.002.031
		Loudspeaker chassis	28.255.330
		Notched ring (Service clamping ring for loudspeakers)	28.445.821
		Paper washer	28.445.390
		Single pole plug	08.281.720
		Mains plug	08.280.350
		Mains lead	33.981.080
TOOLS.			
4		Service oscillator	09.991.260
		Right angle screwdriver	09.990.360
		Matching transformer GM.2295	09.991.310
7		Universal testboard, type 4256	09.991.030
8		Universal chassis holder	09.991.380
9		Box spanner for electrolytic condenser	09.991.540
		Lever for fixing coils	09.991.560
6		Test prod	09.991.622
2		15° jig	09.991.741
13		Centring jig for loudspeaker	09.991.022
		Pertinax gauges	09.990.840
3		Insulated screwdrivers for trimming	09.991.501
		Insulated trimming spanner	09.991.810

VALVE VOLTAGES AND CURRENTS.

	L1 (FC4)	L2 (VP4B)	L3 (TDD4)	L4 (PEN A4)	
V _a	265	245	105	250	V.
V _{g'}	—	155	—	260	V.
V _g 2.3.5	80	—	—	—	V.
I _a	2.0	5.0	1.0	38	mA.
I _{g2}	1.5	—	—	—	mA.
I _g 3.5	4.0	—	—	—	mA.
I _g	—	2.0	—	4.0	mA.

Voltage across C1 = 290 v.

Voltage across C2 = 275 v.

The voltages are measured with voltmeters having a resistance of 2,000 ohms per volt. Moving coil voltmeters give readings which depend upon the resistance used and the current consumption of the meter itself. The values given above are the mean of several measurements, therefore some readings obtained may differ appreciably due to the tolerances of the components as well as the valves. Before finally deciding that a valve is defective it is recommended that a replacement test with the same type of valve is made.

COILS.

Designation.	Description.	Code No.	Resistance.
S1	Mains transformer	28.529.540 or 28.527.950	
S2			
S3			
S4			
S5	Choke coil	28.546.080	350 Ohm
S6			
C13	12—170 $\mu\mu\text{F}$	28.570.480	138 Ohm
S7			
S18			
C14	2.5—30 $\mu\mu\text{F}$	28.570.540	100 Ohm
S9			
S10			
S11	2nd band pass coil	28.570.490	48 Ohm
S12			
S15			
C15			
S13	Short wave coil	28.587.080	0.05 Ohm
S14			
S15	Oscillator coils	28.570.500	32 Ohm
C17			
C18	2.5—30 $\mu\mu\text{F}$		4 Ohm
S16			
S17	Short wave oscillator coil	28.587.090	9 Ohm
S18			
S19			
S20			
S21	Variable I.F. coil	28.570.530	140 Ohm
C23			
S22	2nd I.F. coil	28.570.720	137 Ohm
S23			
S24			
C25	12—170 $\mu\mu\text{F}$		35 Ohm
S25			
S26	Choke coil	28.546.210	5 Ohm
S27			
S28	Loudspeaker transformer	28.527.450	350 Ohm
S29			
	Cone and coil	28.220.230	0.3 Ohm
	Quality corrector coil	28.587.170	4 Ohm
			160 Ohm

VALVES AND PILOT LAMPS.

L1	L2	L3	L4	L5	L6-7	L8
FC4	VP4B	TDD4	Pen A4	1821	8042.07	TV4

S:	29	25	23, 24, 22	20, 21	13, 19	18	14, 17, 7, 6, 10, 11, 12, 14, 15, 16, 17, 6
C:	2, 4, 2, 1	4, 4, 1	3, 7	3, 7	5, 6, 23, 30, 32, 20, 46, 9, 35, 33, 25, 24, 9, 27	5, 6, 23, 10, 50, 11, 12, 22, 40, 63, 34, 28, 46	47, 16, 17, 14, 13, 29, 5, 18
R:	19, 22, 15	9	20, 21	8, 16, 25, 28, 17, 39, 7, 3, 1, 18, 3, 6, 27, 20, 12	13, 5	10, 24, 35, 14, 34, 38	11, 31, 4

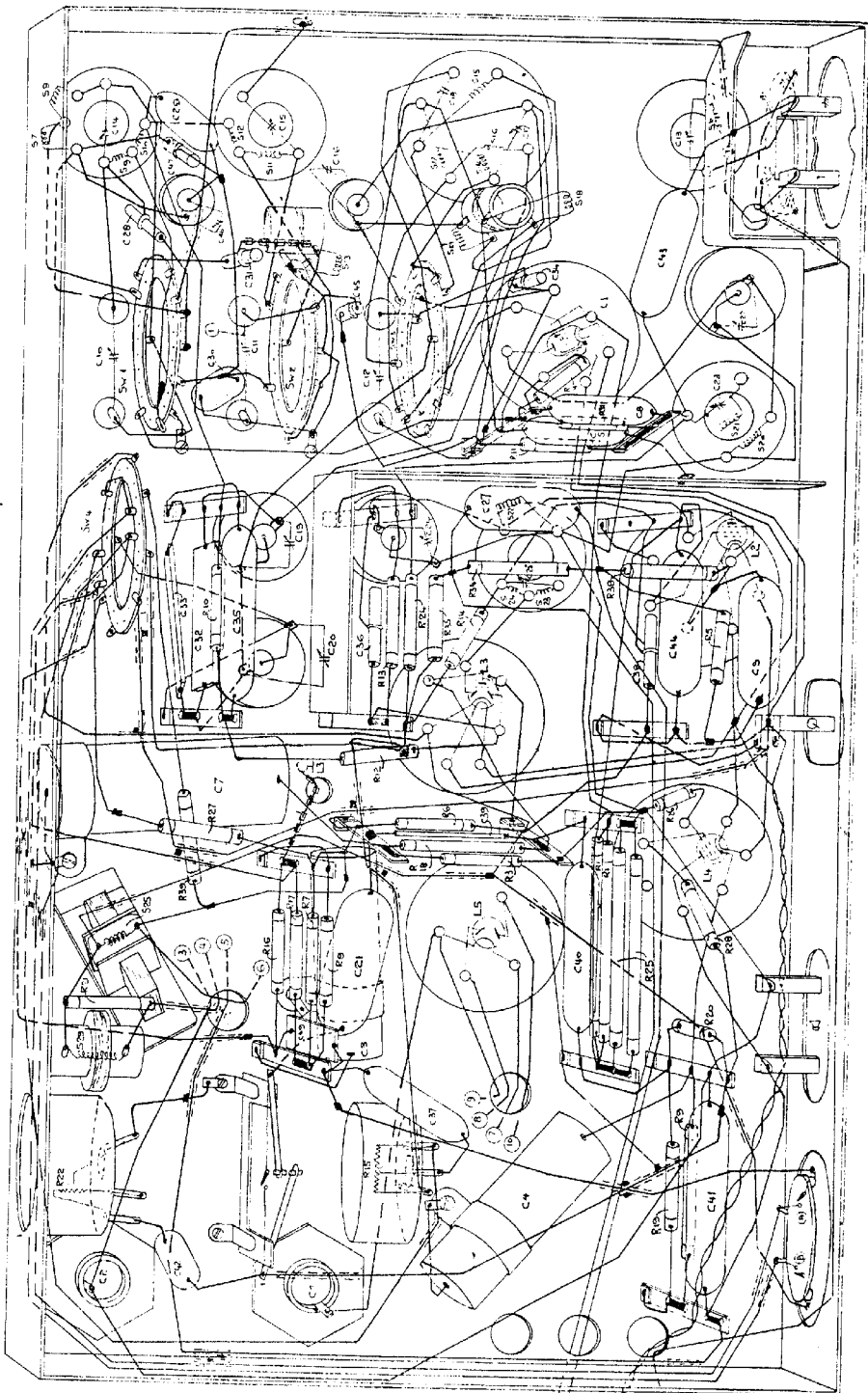

CONDENSERS.

Designation.	Value.	Code No.
C1	32 μ F	28.180.130
C2	32 μ F	28.180.130
C3	50 μ F	28.182.000
C4	50 μ F	28.182.000
C5	0.1 μ F	28.199.090
C7	0.5 μ F	28.199.160
C8	50000 $\mu\mu$ F	28.201.150
C9	0.1 μ F	28.201.180
C10	11—490 $\mu\mu$ F	28.211.421
C11	11—490 $\mu\mu$ F	
C12	11—490 $\mu\mu$ F	
C13	12—170 $\mu\mu$ F	see coils
C14	2.5—30 $\mu\mu$ F	see coils
C15	2.5—30 $\mu\mu$ F	see coils
C16	2.5—30 $\mu\mu$ F	28.211.830
C17	2.5—30 $\mu\mu$ F	see coils
C18	2.5—30 $\mu\mu$ F	see coils
C19	12—170 $\mu\mu$ F	28.211.310
C20	12—170 $\mu\mu$ F	28.211.310
C21	0.1 μ F	28.201.180
C22	12—170 $\mu\mu$ F	28.211.310
C23	12—170 $\mu\mu$ F	see coils
C24	12—170 $\mu\mu$ F	28.211.310
C25	12—170 $\mu\mu$ F	see coils
C26	500 $\mu\mu$ F	28.192.500
C27	50000 $\mu\mu$ F	28.199.060
C28	10 $\mu\mu$ F	28.206.340
C29	16000 $\mu\mu$ F	28.201.100
C30	25000 $\mu\mu$ F	28.201.120
C31	16 $\mu\mu$ F	28.206.360
C32	650 $\mu\mu$ F	28.192.250
C33	1375 $\mu\mu$ F	28.192.300
C34	100 $\mu\mu$ F	28.206.270
C35	0.1 μ F	28.201.180
C36	10 $\mu\mu$ F	28.206.340
C37	2000 $\mu\mu$ F	28.198.920
C38	100 $\mu\mu$ F	28.206.270
C39	400 $\mu\mu$ F	28.190.190
C40	20000 $\mu\mu$ F	28.199.020
C41	4000 $\mu\mu$ F	28.199.710
C42	8000 $\mu\mu$ F	28.198.980
C43	0.1 μ F	28.201.180
C44	0.1 μ F	28.199.090
C45	2 $\mu\mu$ F	28.205.880
C46	2.5—30 $\mu\mu$ F	28.211.830
C47	20 $\mu\mu$ F	28.206.370
C49	250 $\mu\mu$ F	28.190.170

RESISTANCES.

Designation.		Value.	Code No.
R1	2 \times 1 Watt	40000/2 Ohm	28.771.060
R3	0.5 Watt	50000 Ohm	28.770.420
R4	0.25 Watt	250 Ohm	28.773.640
R5	0.25 Watt	800 Ohm	28.773.690
R6	0.25 Watt	32 Ohm	28.773.550
R7	0.25 Watt	3200 Ohm	28.773.750
R8	0.25 Watt	4000 Ohm	28.773.760
R9	0.5 Watt	160 Ohm	28.774.890
R10	0.25 Watt	0.1 M. Ohm	28.773.900
R11	0.25 Watt	50.000 Ohm	28.773.870
R12	0.5 Watt	1 M. Ohm	28.770.550
R13	0.25 Watt	0.5 M. Ohm	28.773.970
R14	0.25 Watt	0.1 M. Ohm	28.773.900

S: 6, 7, 8, 12, 3, 4, 9, 10, 11, 12, 5, 13, 14, 15, 16, 17, 18, 19, 20, 21, 22, 23, 24, 25, 26, 27, 28, 29.
 C: 13, 26, 46, 47, 14, 28, 10, 29, 30, 31, 15, 11, 2, 3, 4, 5, 8, 34, 12, 17, 18, 19, 20, 32, 33, 5, 44, 16, 35, 22, 43, 23, 9, 27, 24, 36, 37, 49, 25, 38, 3, 39, 21, 40, 7, 42, 4, 41.
 R: 10, 32, 4, 31, 11, 1, 25, 36, 24, 12, 38, 5, 35, 34, 13, 11, 15, 16, 17, 16, 7, 8, 27, 15, 19, 37, 22, 28, 9, 36, 39, 21.

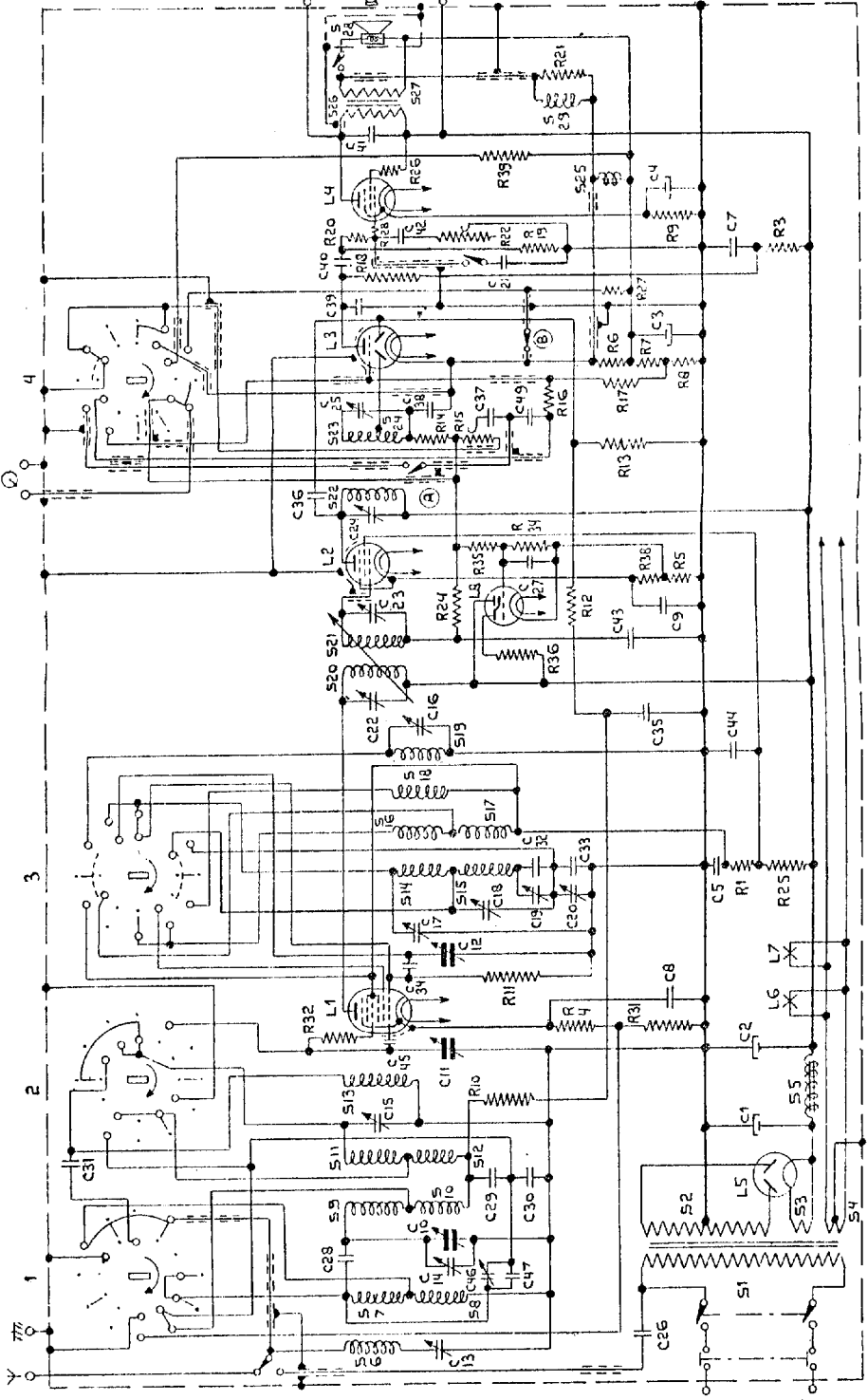

RESISTANCES.

Designation.		Value.	Code No.	Designation.		Value.	Code No.
R15		0.5 M. Ohm	28.811.261	R26	0.25 Watt	64 Ohm	28.773.580
R16	0.5 Watt	1.6 M. Ohm	28.770.570	R27	0.25 Watt	32 Ohm	28.773.550
R17	0.5 Watt	1.6 M. Ohm	28.770.570	R28	0.5 Watt	1000 Ohm	28.770.250
R18	0.5 Watt	0.1 M. Ohm	28.770.450	R31	0.25 Watt	2500 Ohm	28.773.740
R19	0.25 Watt	0.8 M. Ohm	28.773.990	R32	0.25 Watt	50 Ohm	28.773.570
R20	0.25 Watt	0.1 M. Ohm	28.773.900	R34	0.5 Watt	1.6 M. Ohm	28.770.570
R21	0.25 Watt	500 Ohm	28.773.670	R35	1 Watt	5 M. Ohm	28.771.270
R22			28.811.270	R36	1 Watt	2 M. Ohm	28.771.230
R24	0.5 Watt	1.6 M. Ohm	28.770.570	R38	0.25 Watt	320 Ohm	28.773.650
R25	1 Watt	32000/2 Ohm	28.771.050	R39	0.25 Watt	10 Ohm	28.773.500

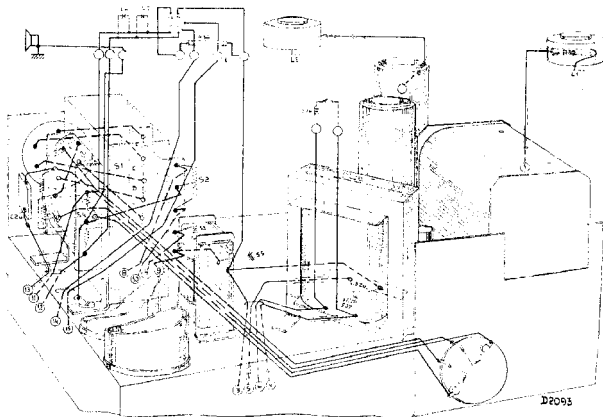

Fig. 15

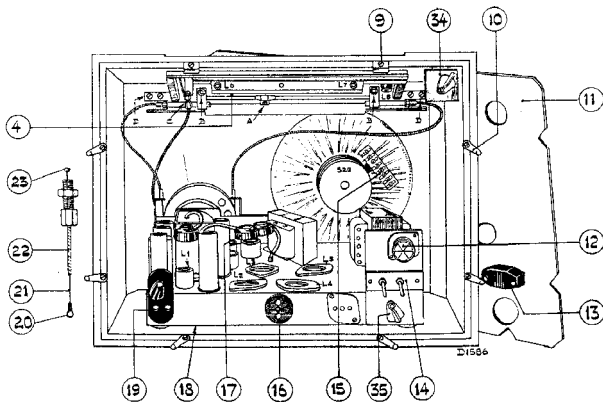

Fig. 16

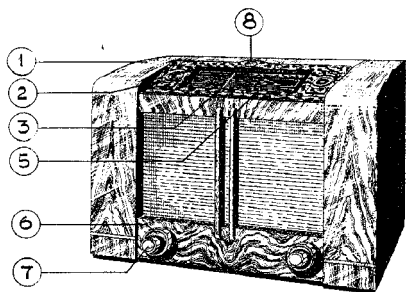

Fig. 17

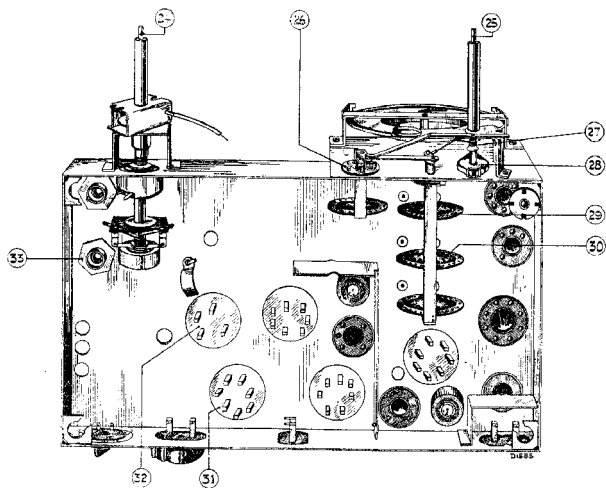

Fig. 18